

Technical data sheet

Rung CK 40

Item number: 6008232



CK40 rung for use in heavy-duty vertical ladders and in IS 8 supports.
The maximum rung load is 175 kg.

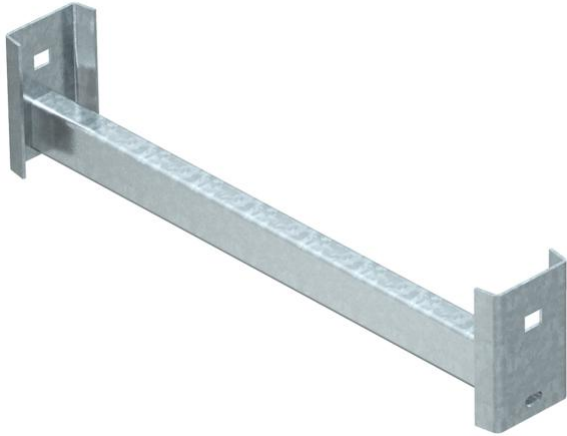

St Steel

FT Hot-dip galvanised

Master data

Item number	6008232
Type	CK 40 30 FT
Description 1	C-frame
Description 2	for IS 8 support
Manufacturer	OBO
Dimension	B254mm
Material	Steel
Surface	Hot-dip galvanised
Surface standard	DIN EN ISO 1461
Smallest sales unit	1
Unit of quantity	Piece
Weight	95.5 kg
Weight unit	kg/100 pc.

Technical data sheet

Rung CK 40

Item number: 6008232



Dimensions

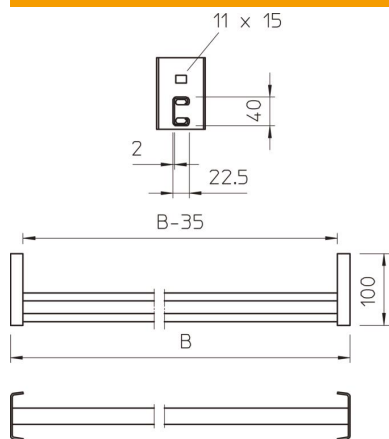

lampDimension WxH	40 x 22,5 mm
Length	254 mm
Width	254 mm
Height	100 mm

Technical data

Material thickness	2 mm
Slot width	18 mm