

Technical data sheet

EÜK PVC underfloor installation duct, duct height 25 mm

Item number: 7425900



Trapezoidal duct, one-compartment, for use in cement screeds and under false floors.



PVC Polyvinylchloride

Master data

Item number	7425900
Type	DU 6025
Description 1	Underfloor duct
Description 2	for UDSPD
Manufacturer	OBO
Dimension	25x60x3000
Colour	Light grey
Material	Polyvinylchloride
Smallest sales unit	3
Unit of quantity	Metre
Weight	43 kg
Weight unit	kg/100 m

Technical data sheet

EÜK PVC underfloor installation duct, duct height 25 mm

Item number: 7425900



Dimensions

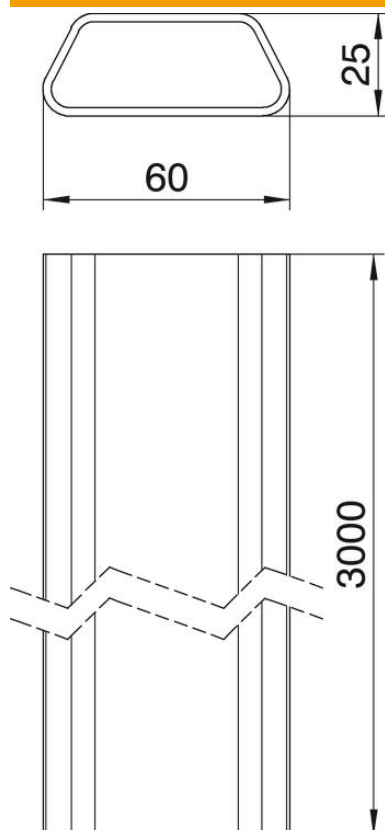

Length	3,000 mm
Width	60 mm
Height	25 mm

Technical data

Number of compartments	1 St.
Duct height, min.	25 mm
Usable cross-section	10.3 cm ²
Cross-section, draw a	1030 mm ²