

Technical data sheet

90° mesh cable tray bend G

Item number: 6001963



90° bend, horizontal, for all mesh cable trays of 55 mm side height.

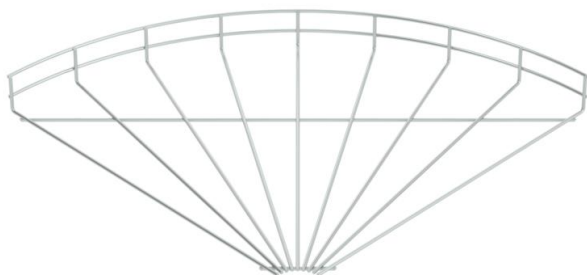

St Steel

G Electrogalvanized

Master data

Item number	6001963
Type	GRB 90 550 G
Description 1	90° mesh cable tray bend
Manufacturer	OBO
Dimension	55x500
Material	Steel
Surface	Electrogalvanized
Surface standard	EN ISO 19598 / EN ISO 4042
Smallest sales unit	1
Unit of quantity	Piece
Weight	95.5 kg
Weight unit	kg/100 pc.

Technical data sheet

90° mesh cable tray bend G

Item number: 6001963



Dimensions

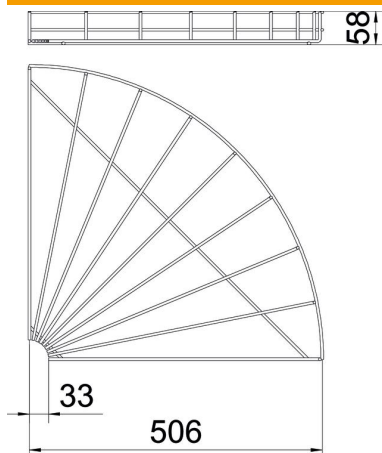

Width	500 mm
Width	19.69 in
Height	55 mm

Technical data

Bend (angle)	90°
Connector version	Without connectors
Type	Horizontal bend
Maintain electrical functions	no
Rustproof steel, pickled	no