

Technical data sheet

Cover for 90° bend A2

Item number: 6226058



Cover with turn buckles for covering 90° cable ladder bends with welded rungs.



A2 Stainless steel

2B Bright, treated

Master data

Item number	6226058
Type	LBD 90 600 R3 A2
Description 1	90° bend cover
Description 2	with turn buckle
Manufacturer	OBO
Dimension	B600
Material	Stainless steel
Surface	Bright, treated
Surface standard	
Smallest sales unit	1
Unit of quantity	Piece
Weight	725 kg
Weight unit	kg/100 pc.

Technical data sheet

Cover for 90° bend A2

Item number: 6226058



Dimensions

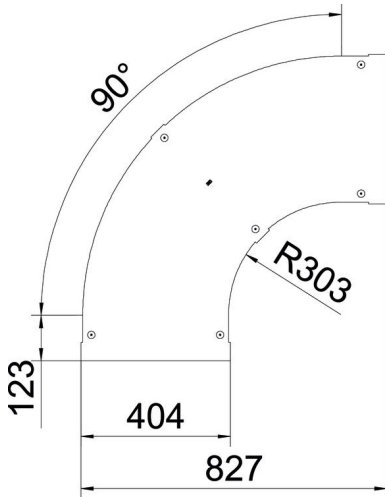

Width	600 mm
Plate thickness	1.25 mm
Dimension B	600 mm

Technical data

Bend (angle)	90°
Fastening type	Sash lock
Maintain electrical functions	no
Suitable for mesh cable tray	no
Suitable for cable ladder	yes
Suitable for cable tray	no
Change of direction	Horizontal
Rustproof steel, pickled	no
Hinged	no