

# Technical data sheet

Trunking end piece, height 40–150 mm

Item number: 7424280

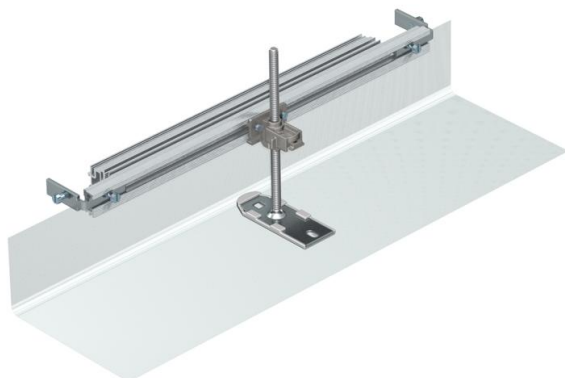

Ready-to-mount trunking end piece, consisting of a flexible apron with side and floor covering guide profiles. The scope of delivery contains trunking connection brackets and a height-adjustable fixing bracket.



**St** Steel

**FS** Strip galvanized

## Master data

Item number	7424280
Type	OKA-G20040150ES
Description 1	End cover
Description 2	for OKA-G and OKA-W
Manufacturer	OBO
Material	Steel
Surface	Strip galvanized
Surface standard	DIN EN 10346
Smallest sales unit	1
Unit of quantity	Piece
Weight	33 kg
Weight unit	kg/100 pc.

# Technical data sheet

Trunking end piece, height 40–150 mm

Item number: 7424280



## Dimensions

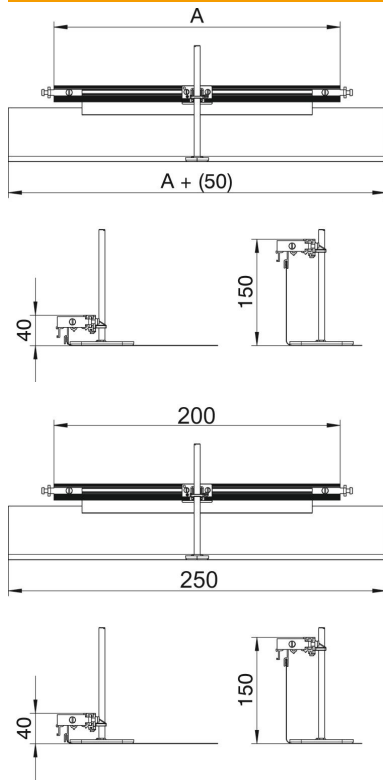

Length	260 mm
Width	200 mm
Dimension h	40 mm

## Technical data

Suitable for screed-flush closed underfloor ducts	no
Suitable for flushfloor, open underfloor trunking	no
Suitable for screed-covered underfloor ducts	no
Trunking height, max.	150 mm
Duct height, min.	40 mm
Height-adjustment range, max.	110 mm
Height-adjustment range, min.	0 mm