

# Technical data sheet

## Cover, 45° bend FS

Item number: 6036400



Cover for 45° bend fitting for lockable and screw-on cable trays in indoor areas, to protect cables against damage and soiling. Fastening with pre-mounted sash lock and through attachment of the section cover. Suitable for all side heights. The cover can be used with fittings of all side heights.



**St** Steel

**FS** Strip galvanized

### Master data

Item number	6036400
Type	RBD 45 100 FS
Description 1	Cover
Description 2	for 45° bend
Manufacturer	OBO
Dimension	B100mm
Material	Steel
Surface	Strip galvanized
Surface standard	DIN EN 10346
Smallest sales unit	1
Unit of quantity	Piece
Weight	11 kg
Weight unit	kg/100 pc.

# Technical data sheet

Cover, 45° bend FS

Item number: 6036400



## Dimensions

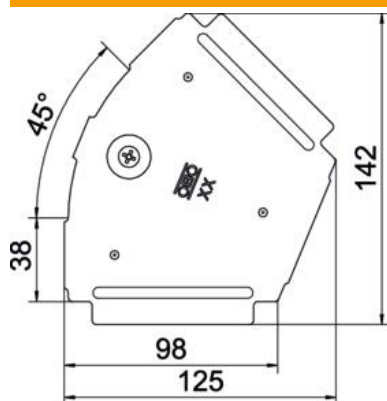

Length	125 mm
Width	100 mm
Plate thickness	0.75 mm

## Technical data

Bend (angle)	45°
Number of turn buckles	1 St.
Fastening type	Sash lock
Maintain electrical functions	no
Suitable for mesh cable tray	no
Suitable for cable ladder	no
Suitable for cable tray	yes
Change of direction	Horizontal
Rustproof steel, pickled	no
Hinged	no
Permitted temperature range, max.	120 °C
Permitted temperature range, min.	-20 °C