

# Technical data sheet

## 110 FS cross-over

Item number: 7004648

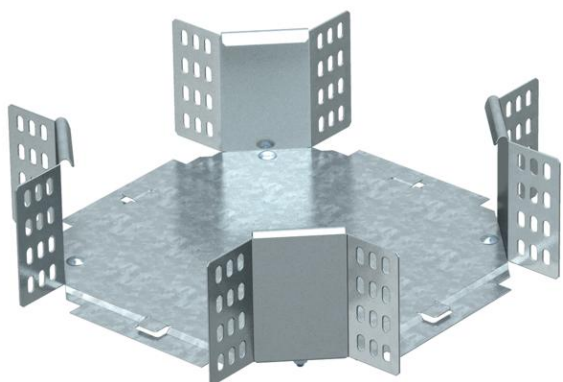

Horizontal cross-over for all cable tray types of 110 mm side height.  
The fitting is shipped in an unmounted state. Including appropriate fastening material.



**St** Steel

**FS** Strip galvanized

### Master data

Item number	7004648
Type	RK 110 FS
Description 1	Cross over
Description 2	horizontal + angle connector
Manufacturer	OBO
Dimension	110x100
Material	Steel
Surface	Strip galvanized
Surface standard	DIN EN 10346
Smallest sales unit	1
Unit of quantity	Piece
Weight	110 kg
Weight unit	kg/100 pc.

# Technical data sheet

## 110 FS cross-over

Item number: 7004648



### Dimensions

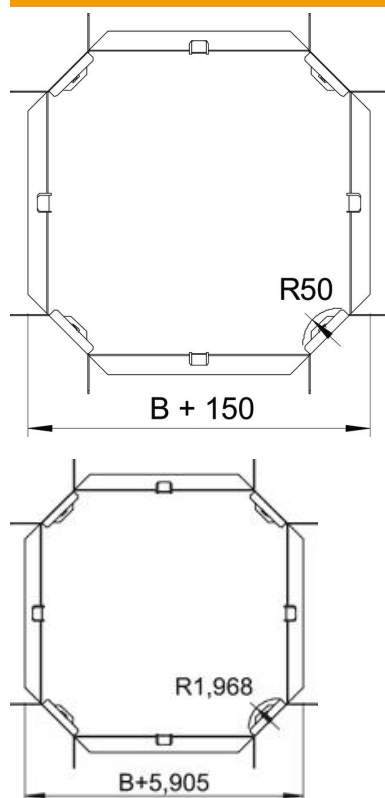

Width	100 mm
Width	4 in
Height	110 mm
Height	4 in
Dimension B	100 mm
Dimension R	50 mm

### Technical data

Bend (angle)	90°
Connector version	Supplied connectors
Maintain electrical functions	no
Material thickness, floor plate	1 mm
Change of direction	Horizontal
Rustproof steel, pickled	no
Wide-span version	no
Type of connector, cable support system	Screwed
Rail thickness	1.25 mm