

Technical data sheet

UP Plaster compensation ring 12 mm, flush-mounted device box

Item no. 2003742



Plaster compensation ring for Ø 60 mm flush-mounted box, to screw on.



PS Polystyrene

Master data

Item no.	2003742
Type	ZU 12-PR
Description 1	UP Plaster compensation ring
Description 2	for flush-mounted device box
Available from	01.10.2021
Dimension	Ø60mm, H12mm
Colour	Signal red
Material	Polystyrene
Material symbol	PS
Smallest sales unit (VG)	25 Piece
Weight	0,65 kg/100 pc.

Technical data

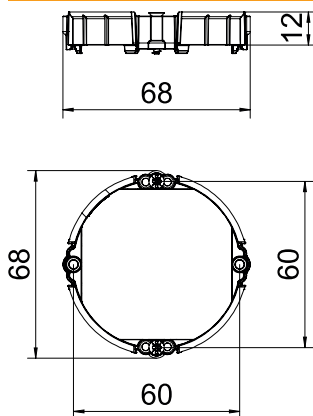

Height	12,00 mm
Diameter	68,00 mm
Flame-resistant	acc. to VDE 0471/IEC 60695-2-11, test temperature 650°C
Shape	Round
Halogen-free	<input checked="" type="checkbox"/>
With bolts	<input checked="" type="checkbox"/>
Impact-resistant	<input checked="" type="checkbox"/>